

CHIPSEN

공 차	0,000	모델명	단위	mm	문서번호						
	0,00					± 0,05	DC-3-3	비율	1:1	작성일자	2021-12-22
	0,0					± 0,10					
	0,					±			☉	수정일자	
	ANGLE (각도)					±1°		버전	A0	재료	

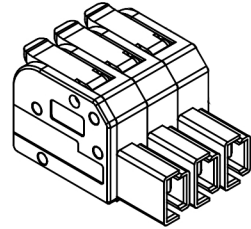

옆면으로 조립 확장 가능

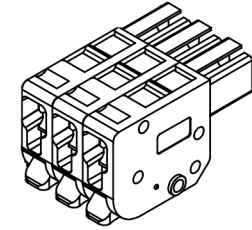
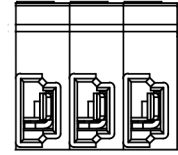

모델명	DC-3-3
제품명	전선커넥터
전선탈피	12mm / 0.39in
온도범위	-20°C -- 105°C
홀 위치	X+N 위치 (간격5,5)
제품 소재	난연성 나일론,PC
접속단자	황동
체결부	스테인리스 스틸

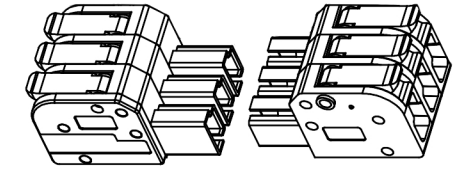
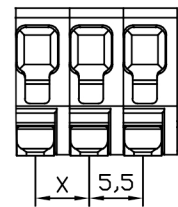
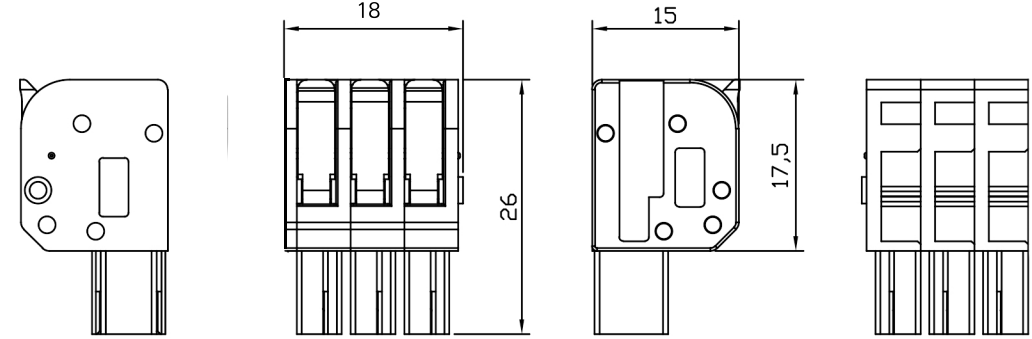

동일한 홀을 통한 결합 및 분리

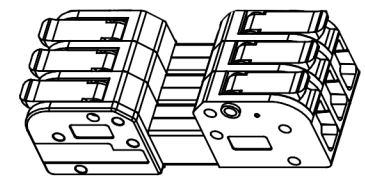

심사:

심의:

작성: