

재질	BODY.COVER	PC	TML	Brass 2/1h	배율	2 : 1
----	------------	----	-----	------------	----	-------

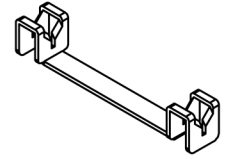

(평면도)

(등각투상도)

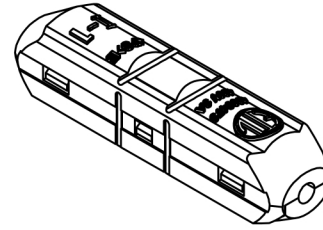
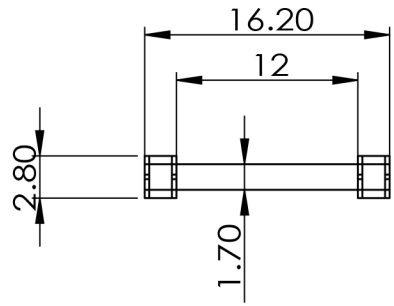
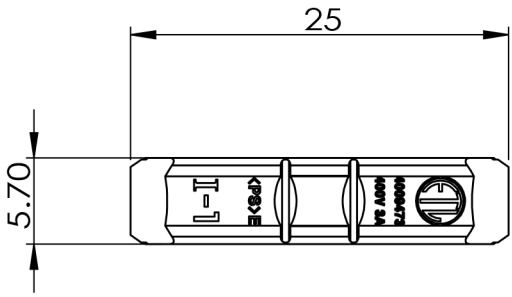
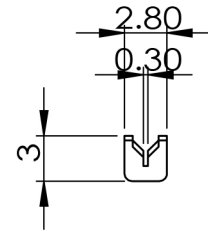
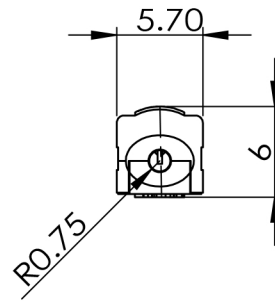
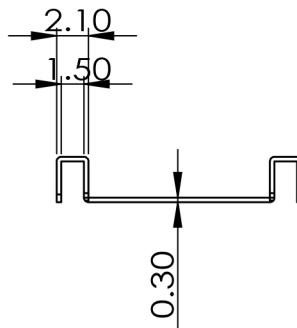
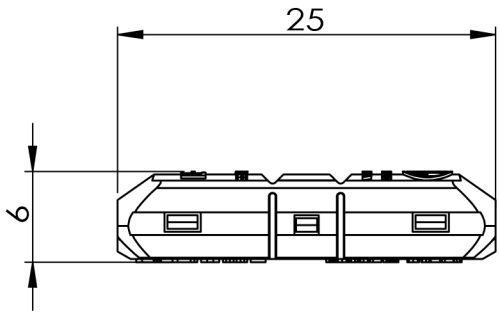

(정면도)

(측면도)

CHIPSEN	도명	I-1		
	치수	mm	날짜	2014.07.07
	설계	박용준	확인	