

재질	BODY.COVER	PC	TML	Brass 2/1h	배율	1.5 : 1
----	------------	----	-----	------------	----	---------

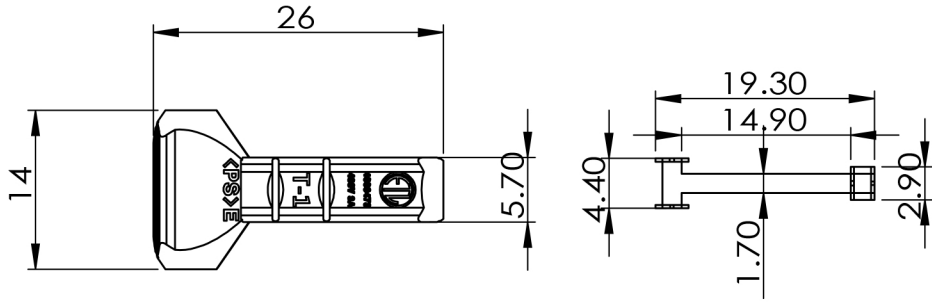

(평면도)

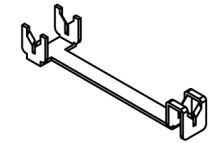
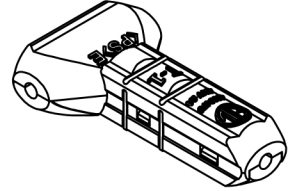

(등각투상도)

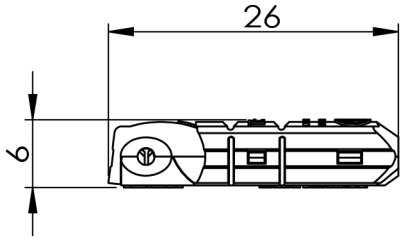

(정면도)

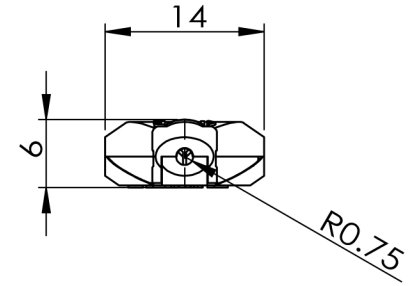
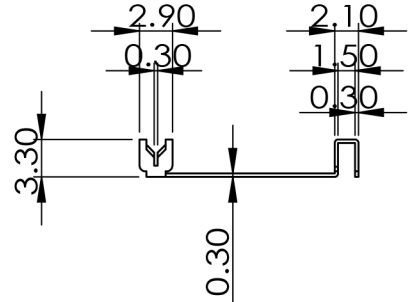

(측면도)

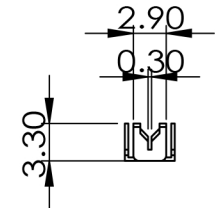

<b>CHIPSEN</b>	도명	T-1		
	치수	mm	날짜	2014.07.07
	설계	박용준	확인	